



Newsletter

06/2014

MPM Production Ltd., Mezilesí 718, 193 00, Praha 9, Czech Republic
tel.:+420 281923 910, fax:+420 281 923 892, e-mail: export@mpm.cz
official website and e-shop: www.cmkkits.com

July newsletter offers two pairs of related aircraft. Both pairs served for reconnaissance and light bombers tasks. Though there's a time gap between them, they clearly illustrate the fast development and the level of aircraft industry in the whole World and also in their countries of origin. We will also offer you World War 2 US transport aircraft featuring interesting camouflages and two long time sold out aircraft kits are back in stock.

July newsletter brings:

IAR employees ing Grossu-Vizuru and ing Carpa designed in 1936 biplane three seater reconnaissance and tactical bomber IAR-37 according to the specifications issued by Royal Romanian Air Force. The very next year was the prototype test flown by M. Manolesku. The crew was housed under glazed canopy. The armament consisted of four machineguns mounted in the wing triggered by the pilot; the gunner manned flexible machinegun for defensive fire rearward. The observer operated Estopey bomb sight, radio and photo camera. For bombing missions the aircraft could carry up to twelve 50Kg bombs or six 100 Kg bombs. IAR-37 was powered by IAR K.14-II engine (Gnome-Rhone). Thanks to the relative unreliability and the lack of these power plants led to the cease of the production. Only 50 machines were produced when the production was switched to IAR-38. This version featured lengthened wingspan but most importantly it was powered by reliable BMW-132 engine. Additional 75 machines of this version were produced. Then the production was switched to the final version IAR-39/39A powered by IAR K.14-III/IV engine (Gnome-Rhone). 15 squadrons were equipped with IAR-37/38/39 in the beginning of the war against Soviet Union. Although the combat operations steadily decreased available aircraft, even in 1944 after the coup and subsequent join of Allied forces, the IAR-37 and IAR-38 were deployed against the Germany. They flew combat missions until the end of the war.

Bar Code: 8594071084486

SH72290 IAR 37 "Rumanian Light Bomber" 1/72

The first kit from the pair of the Rumanian machines contains two sprues with plastic parts, injected clear parts, highly detailed resin engine bombs, other small details and photo-etched parts. Decals included offer three machines that illustrate the changes in the Rumanian government during th World war 2. Two machines feature



cockades but the time distance between them is five years. While one served in the pre war period just before the outbreak of World War 2 the other one, with same cockades but with white stripes on the wings and fuselage fought with allies against the Germans. The last machine sports the Michal's crosses and was deployed against the Soviet Union on the Eastern

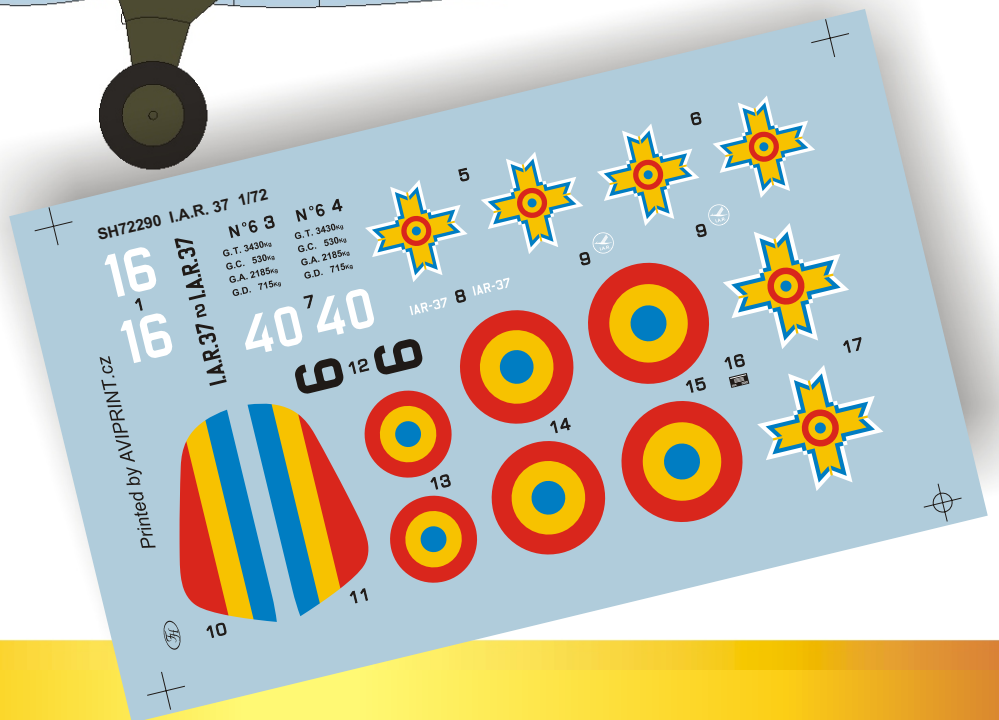
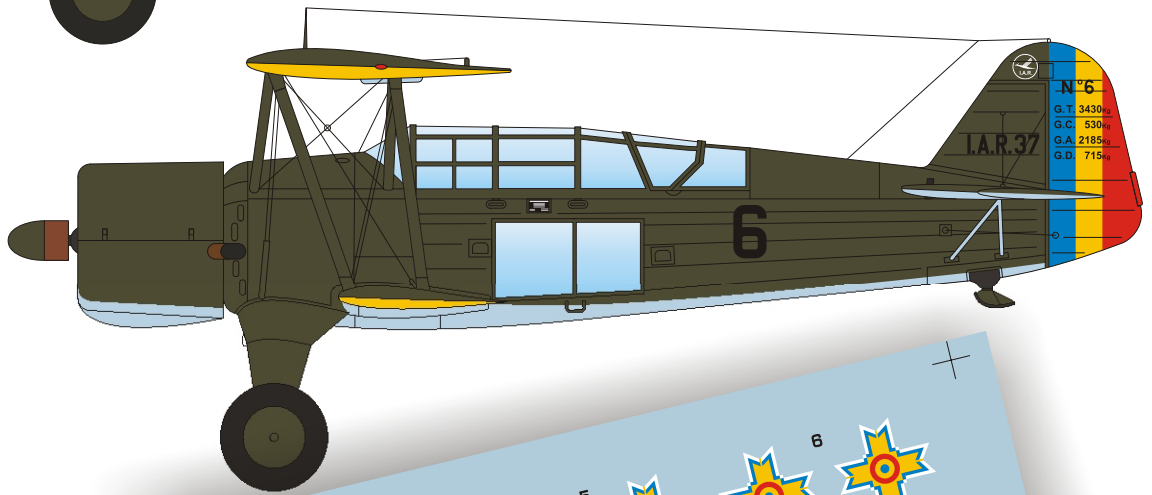
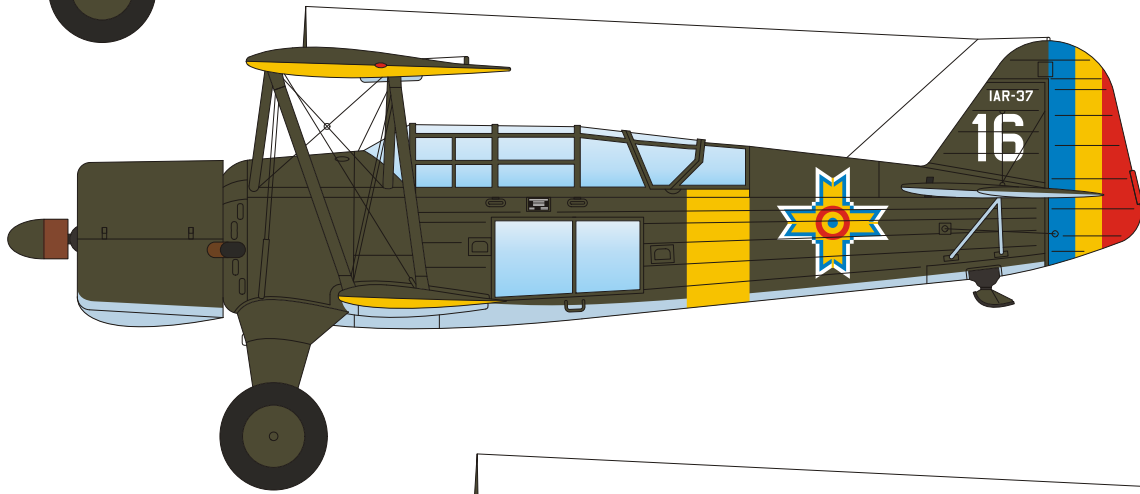
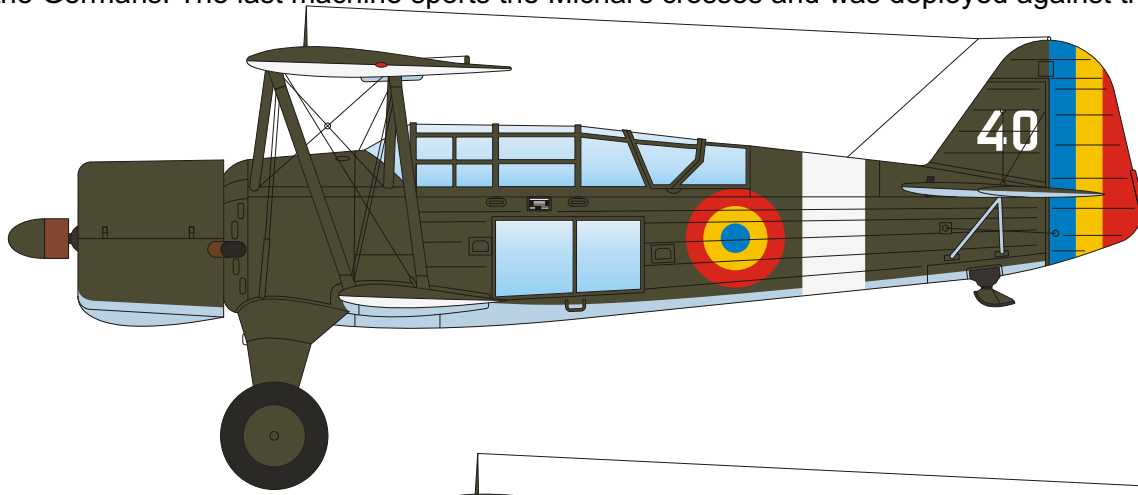

The second kit from the pair of the Rumanian machines contains two sprues with plastic parts, injected clear parts, highly detailed resin engine bombs, other small details and photo-etched parts, as the previous one. The upper wing is, of course, different with bigger span. Also, different are engine cowling and other details. Decals included offer three machines. Two machines sports cockades; one of them carried interesting field applied camouflage. The last machine sports the Michal's crosses and was deployed against the Soviet Union on the Eastern Front.



Caproni Ca.311 belonged to the developmental series of light twin-engined aircraft designed in 1930s by Ing. Pallavicino. At the end of 1930 Regia Aeronautica realized that it is necessary to replace the obsolete reconnaissance IMAM R.37 biplanes. The requirements were specified in the R plan that determined the future development of Italian Air Force. Together with his team Ing. Pallavicino proposed the modification to Ca.310 and it was partially tested on the Ca.310bis machines produced for Yugoslavian Air Force. Therefore no prototype was built but right away the first production machine, M.M. 11479. It was test flown on April 1, 1939 by Ettore Wengi. Instead of 316-345 KW/ 430-470 Hp Piaggio P.VII C.16 engines used on Ca.310/ 310bis the Ca.311 was powered by more powerful version 368 KW/ 500 Hp Piaggio P.VII C.35 engines. Thanks to these engines the aircraft had higher performances and richer equipment. Comparing to the Ca.310 the offensive armament was more efficient. The gun turret was located just behinds the canopy and the defence of the lower side was provided by flwxible machinegun that fired through the slot. Ca.311 was also considered as light bomber and transport aircraft. The production started in three Caproni's affiliates. It was produced in two versions; the original Ca.311 featured smooth nose glazing, Ca.311M (M for modificato) version featured stepped nose glazing. In total, 320 machines were produced; 86 of that number was Ca.311M version. The three seater Ca.311 were deployed in 1940 fights against France, flew combat missions in Africa, over Balkan, on the Eastern front against USSR and, of course in Italy. Several machines were exported to Croatia. At least one machine was captured by RAF.

Bar Code: 8594071084554

SH72307 Caproni Ca.311 1/72

The kit contains three sprues with plastic parts, wings and small parts are injected from standard grey coloured plastic. The fuselage frame is injected completely clear. This feature eliminates the challenging attachment of the fuselage windows for the Ca.311



illustration picture only

version. The spray masks will also help modelers prior camouflage application. The kit also contains detailed resin and photo-etched parts. Decals included offer three machines that illustrate Ca.311 service with Regia Aeronautica.

SH72309 Caproni Ca.311M 1/72 "Italian Adventure in Russia"

Bar Code: 8594071084561

The kit of the Modificato version contains same wing and small parts sprues as the previous kit, also injected from standard grey coloured plastic. The clear fuselage frame features different canopy for Ca.311M. Decals included offer three machines that illustrate Ca.311 service with Regia Aeronautica.



illustration picture only

In the very pre war period Lockheed Company tried to compete with Douglas Dc-3 aircraft. Lockheed model 18 Lodestar was the direct Dc-3 competitor. The wing was taken over from model 14 but fuselage was different, lengthened by 1.68 meter and the tailplanes were also modified. Only few US companies placed their orders for this aircraft, most already contracted Dc-3. Considerably many orders came from foreign countries. In total, 96 civilian machines were ordered. But then came large orders by US Army Air Force and US Navy. The aircraft was produced not only with Wright R-1820 engines but also with P&W R-1830



engines. Lodestars were used for medium range transport aircraft. According to the particular version US Army designated their Lodestar as C-56, C-57, C-59 and C-60. Some of them were confiscated civilian Lodestars. Under the Lend and Lease contract twenty three aircraft (seven C-59 and sixteen C-60) were delivered to RAF. RAF designated them as Lodestar Mk.IA and Lodestar Mk.II. US Navy and USMC Lodestars were designated from R5O-1 to 6. The digit after the hyphen indicates the version. Lodestars were during World War 2 used also by RAAF, SAAF, RCAF, RNZAF, Chilean and Mexican air forces, Free French Air Force and Dutch East Indies Air Force. Due to the high loading capacity and range Lodestar were useful in the Pacific theater.

The kit contains five sprues with plastic parts, injected canopies, resin and photo-etched parts. Decals included offer interesting machines that operated over the Pacific Ocean. USAAF machine is decorated with "Arkansas Traveller" name and, except of military marking even sports civilian Australian registration. Both military and civilian marking sports the overall green RAAF machine. The overall natural metal finished RNZAF Lodestar sports lightnings on the nose served for VIP transports. Decals offer two appearances of this machine; one with RAF like national insignias and wartime New Zealand ones. It is the first RNZAF machine that landed in the occupied Japan. The Dutch East Indies machine sports flower painting and "Princess Margaret" name.

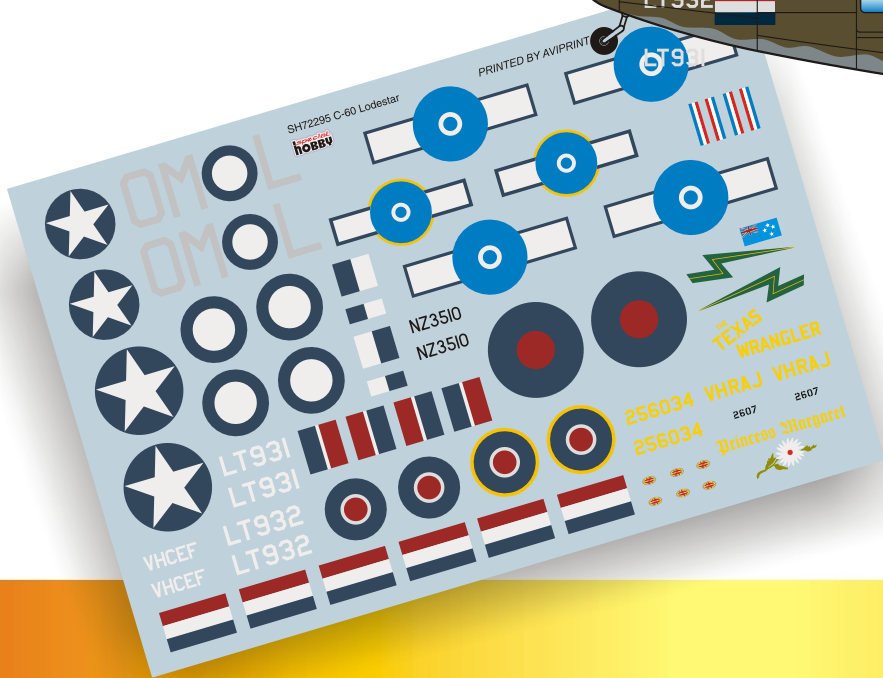
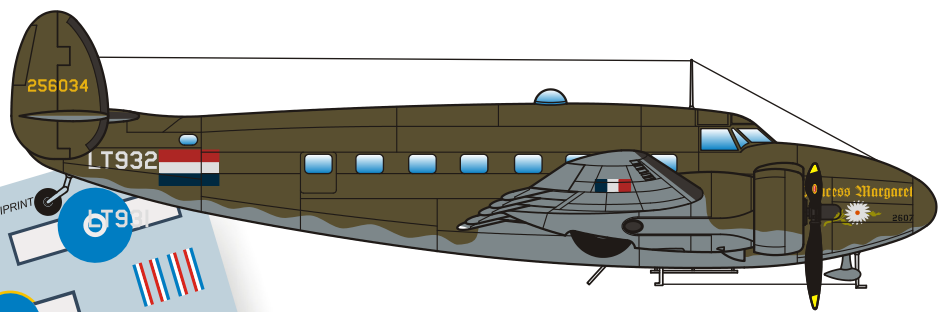
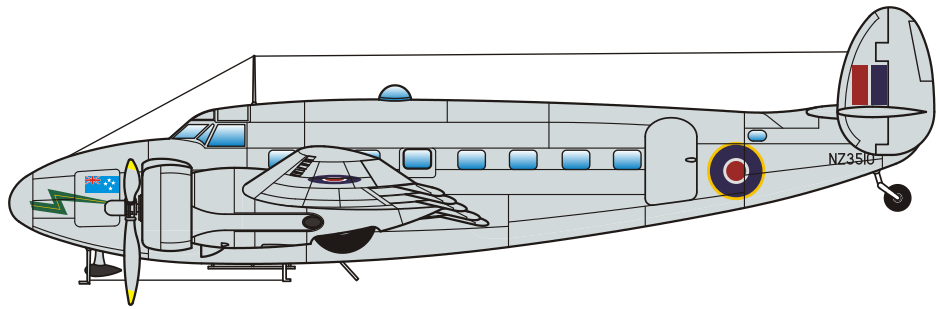
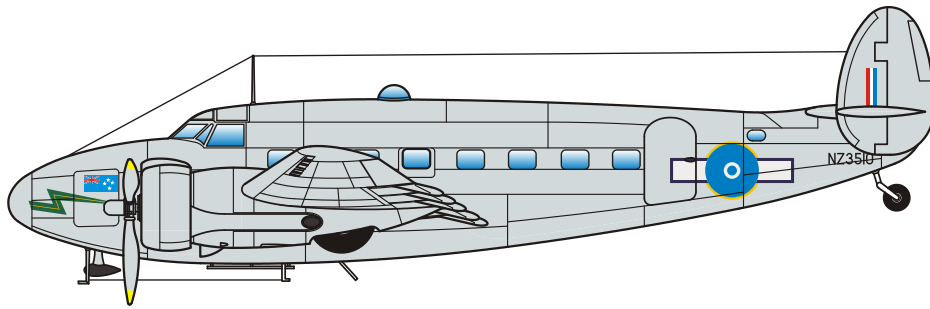
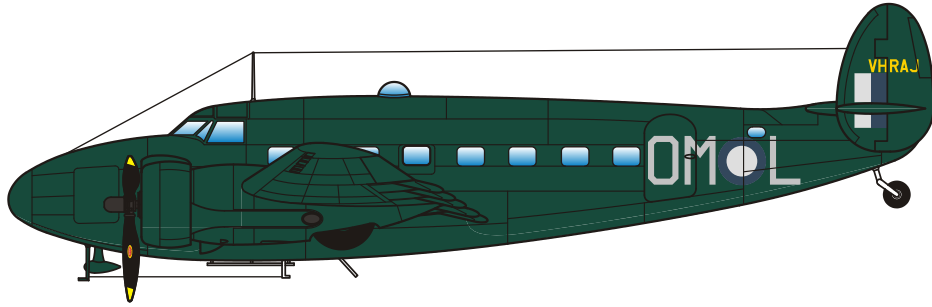
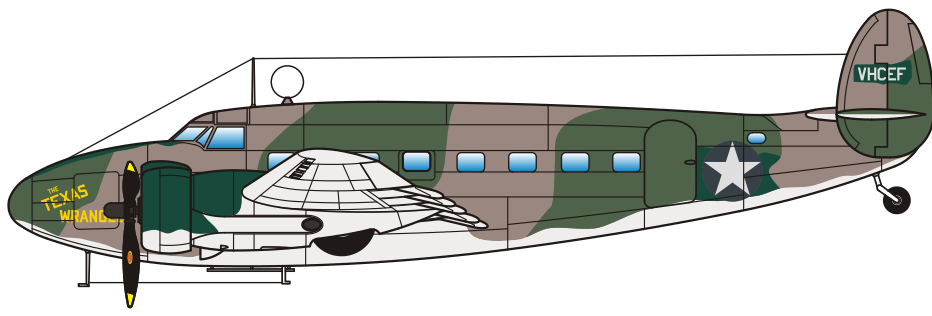

SA72003 A4/V2 Rocket 1/72

Bar Code: 8594071083632

Very quickly sold out highly detailed kit of a German reprisal weapon is back in stock. it will be available again at the end of June.



SH72161 VL Myrsky I 1/72

Bar Code: 8594071081249

The kit of the Finnish fighter aircraft was sold out for more than two years. Finally, it is back in stock. Finnish Air Force used variety of fighter aircraft types during World War 2. Due to some types became obsolete and because of the supplies of German Bf 109s were instable it was decided to develop domestic fighter Myrsky. Finally, after long and difficult development Finnish AF produced and deployed the fighters into final war's combats against USSR.



The kit contains two sprues with plastic parts, injected canopy, detailed resin and photo-etched parts. Decals

included offer four aircraft. Decals included offer markings for four production machines.

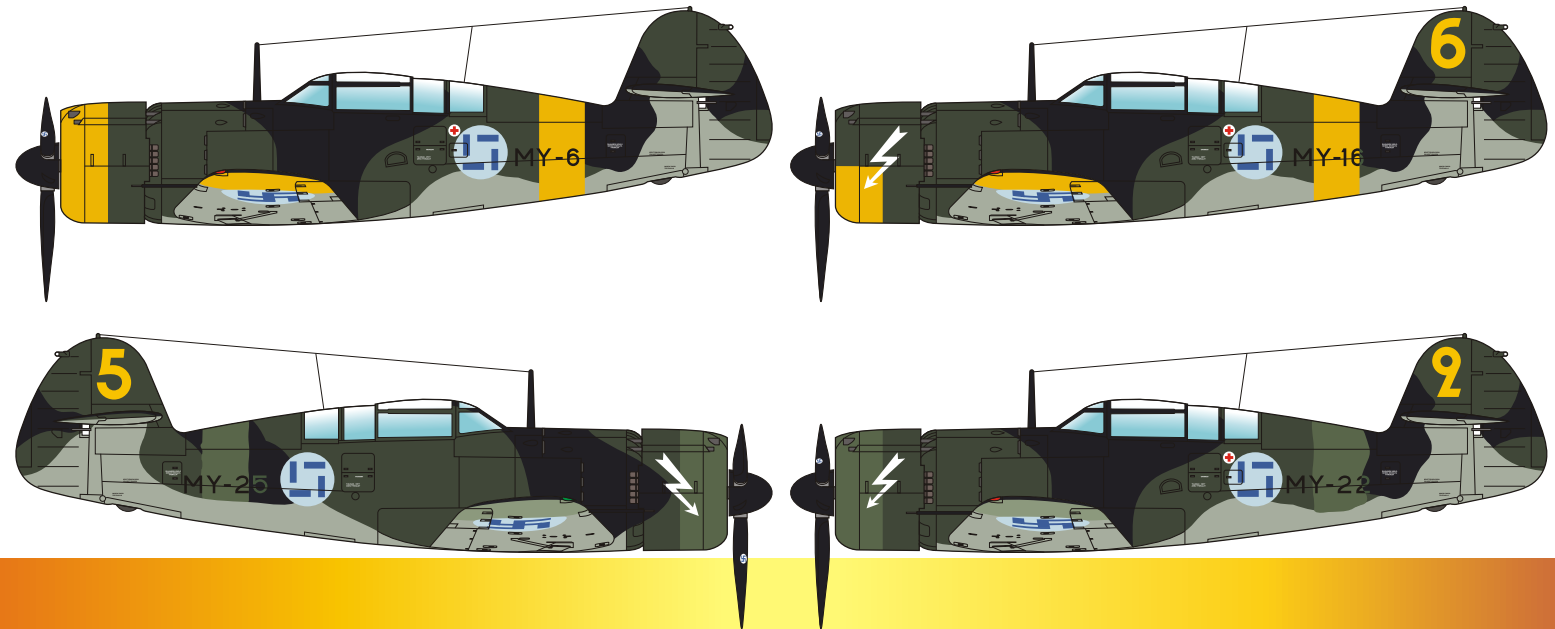

MPM Production continues to prepare its kits completely in 3D design and inject them into metal moulds. Some of the kits are already on sale **A4/V2** rockets, **SS-100 Gigant** tractor and **Meillerwagen** rocket trailer. We present the test shots of the final kits of **AH-1G Cobra**, **AH-1Q/S Cobra** and day fighter versions of **DH 100 Vampire**. Both Vampire and Cobras in quality exceed every kit of these subjects that was in 1/72 scale ever produced. Now it's time to reveal our next project. We had already started to prepare moulds for trainer aircraft **Fouga Magister** and its versions. We will, subsequently release **CM 170 Magister** in both trainer and combat version (including **IDF Tzukit**), aerobatics version with faired over rear canopy and even **CM 175 Zéphyr** naval version. The differences from the standard Magisters comprise lengthened fuselage, different canopy, arrestor hook and strengthened undercarriage.

Fouga CM 170 Magister 1/72

- HIGHLY DETAILED CM170 / 175 MAGISTER / ZÉPHYR MODELS IN SEVERAL VERSIONS TO BE LAUNCHED IN THE NEAR FUTURE
- COMPLETELY 3D DESIGNED, INJECTED INTO METAL MOULDS
- FINE DETAILS, SHAPE AND DIMENSIONAL ACCURACY

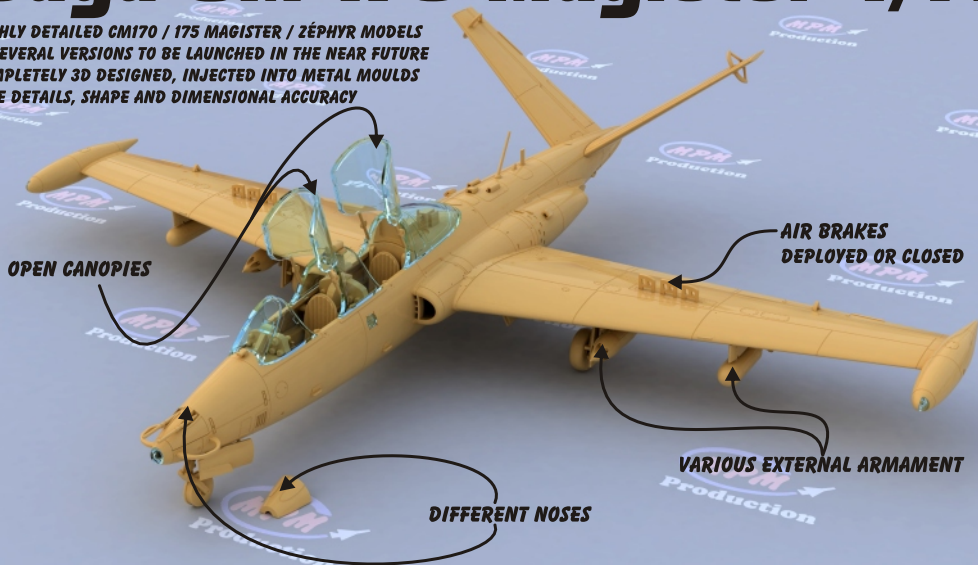

A GOOD MODEL IS WORTH THE WAIT!



Fouga CM 175 Zéphyr 1/72

- HIGHLY DETAILED CM170 / 175 MAGISTER / ZÉPHYR MODELS IN SEVERAL VERSIONS TO BE LAUNCHED IN THE NEAR FUTURE
- COMPLETELY 3D DESIGNED, INJECTED INTO METAL MOULDS
- FINE DETAILS, SHAPE AND DIMENSIONAL ACCURACY



A GOOD MODEL IS WORTH THE WAIT!



Forthcoming new releases:

SH48135

AF-2S Guardian "Submarine Killer" 1/48



SH48158

AF-2W Guardian "Submarine Hunter" 1/48



SH72299

N-3PB "Little Norway" 1/72



SH72250

N-3PB "No. 330 (Norwegian) Squadron RAF" 1/72



SH32057

Bristol M.1C "Wartime Colours" 1/32



SH32060

Bristol M.1C "Checkers & Stripes" 1/32



SH48123

F-86K Sabre Dog "NATO All Weather Fighter" 1/48



SH48126

F-86K Sabre Dog "Armée de l'Air & BundesLuftwaffe" 1/48



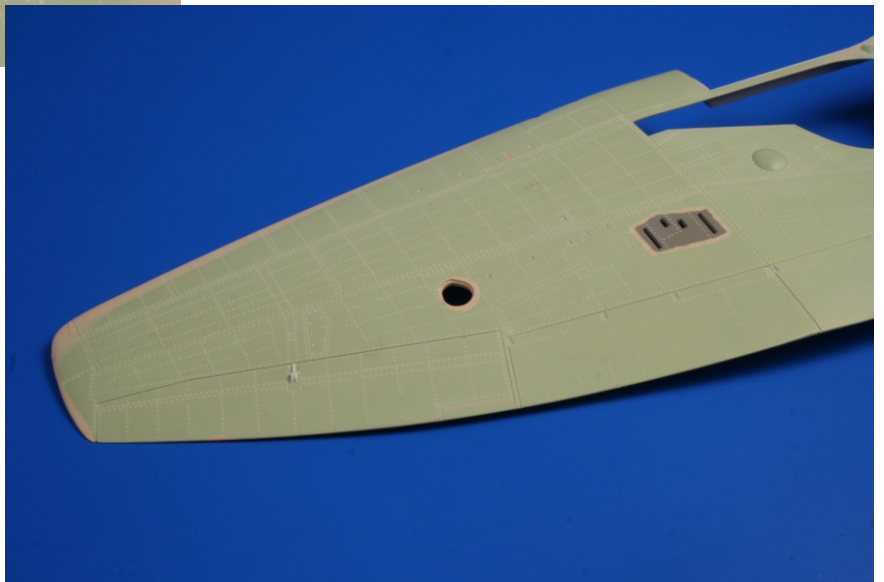
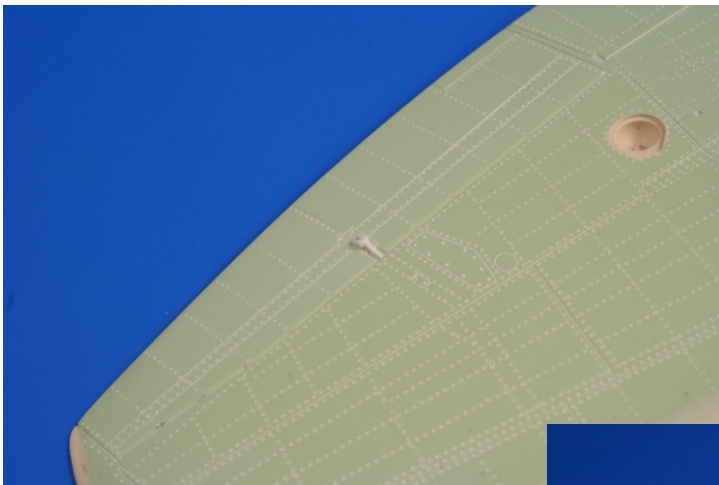



RESIN KITS and SETS 06/2014

MPM Production Ltd., Mezilesí 718, 193 00, Praha 9, Czech Republic
tel.: +420 281 923 909 fax: +420 281 923 910 e-mail: cmk@mpm.cz
official website and e-shop: www. cmkkits.com

ITEM
5088

WWII Luftwaffe 600L Drop Tanks (Long Cigar Type) (2 pcs)

Scale
1/32

Set contains 2 new highly detailed WW II Luftwaffe 600L drop tanks, most commonly used by Ju 88 bombers.
Germany / WWII

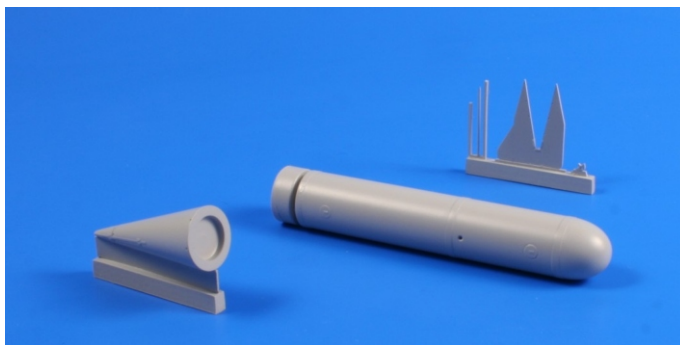

Bar Code: 8595593121147

ITEM
4300

WWII Luftwaffe 900L Drop Tank (2 pcs)

Scale
1/48

Set contains 2 new highly detailed WW II Luftwaffe 900L drop tanks, most commonly used by Ju 88 bombers.
GB / Post WWII

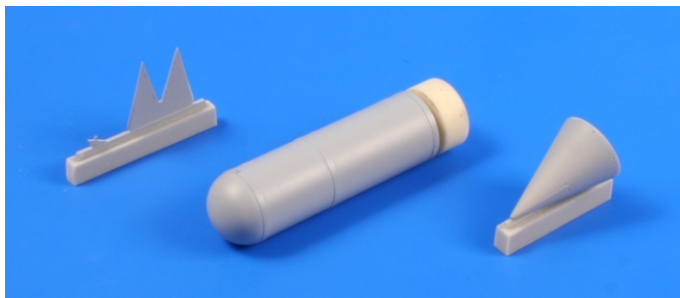

Bar Code: 8595593121154

ITEM
7240

Spitfire PR Mk.XIX - Engine set for Airfix kit

Scale
1/72

Set contains complete Griffon 60 series engine and its compartment for the Spitfire PR Mk.XIX that became famous as the high altitude reconnaissance version of the WW II British fighter aircraft. The engine compartment contains highly detailed resin engine, engine bulkhead, engine bed, oil tank, exhaust stacks and particular covers. The set contains photo-etched parts.

GB / WWII and post WWII

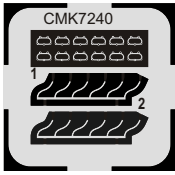

Bar Code: 8595593121161

ITEM
7297

P-40B - Undercarriage set for Airfix kit

Scale
1/72

Set contains new main undercarriage bays, tail bay with dust cover, new tail wheel and particular doors. The main undercarriage bays feature highly detailed canvas dust covers that covered the wing's internal structure.

USA / WWII

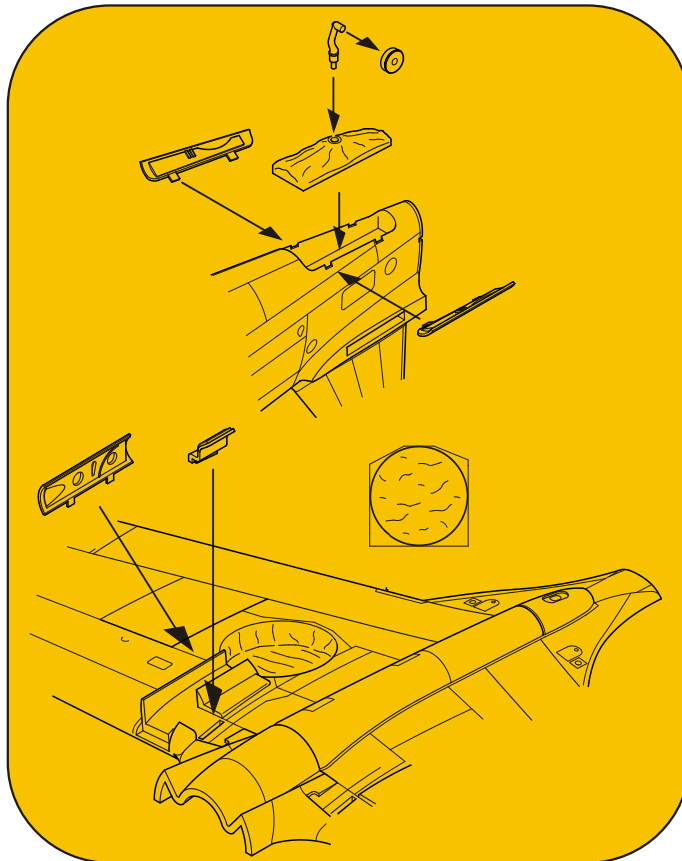

Bar Code: 8595593121178



ITEM
7301

RecceLite reconnaissance Pod (1 pcs)

Scale
1/72

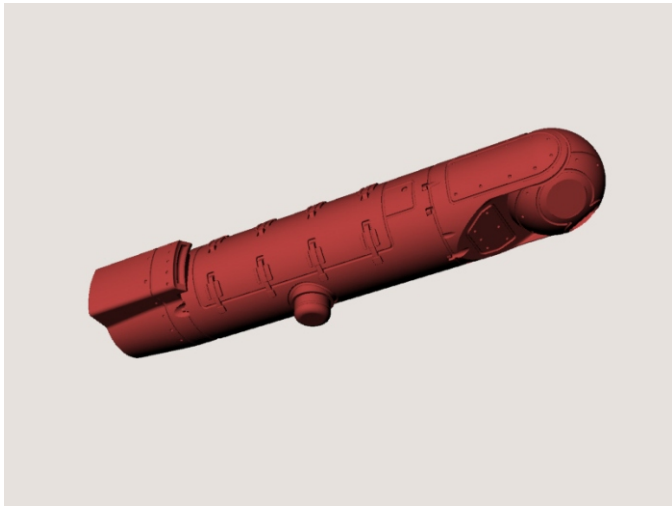

RecceLite Day/Night electro-optical reconnaissance pod (Carl Zeiss optics) is produced by Israeli RAFAEL Company to provide real-time imagery collection and data transfer via data link communications from medium to high flight levels. Except of the Israel, this pod is used for instance by Netherlands, Italy or Chile. Highly detailed resin pod is cast from two parts and can be attached to F-16, F-18, JAS 39 or Tornado IDS. The set contains decal sheet with stencils and 20 color photo-etched Remove Before Flight tags.

NATO/ Modern

Bar Code: 8595593121185

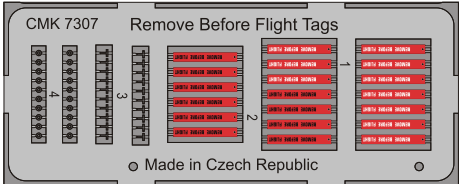

ITEM
7303

Taurus KEPD 350
Long-Range Air-to-Surface Missile (1 pcs)

Scale
1/72

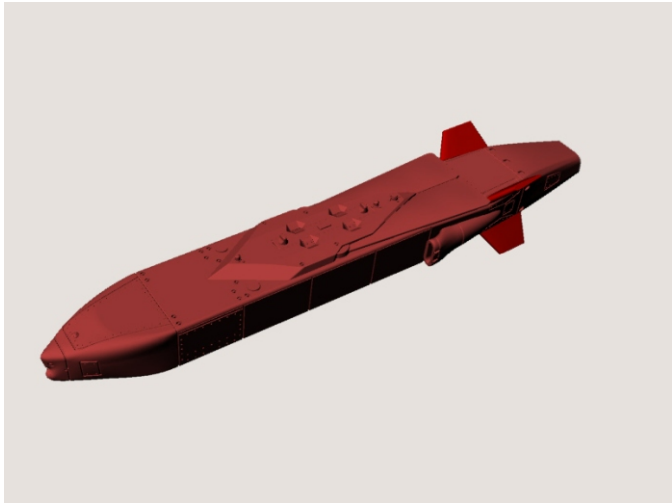
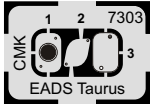

KEPD 350 is a modern European Long range air-to-surface produced by TAURUS Systems (MBDA and Saab) is intended for penetrating hardened targets. It is used by German, Spanish and South Korean air forces and was tested by Swedish Air Force, too. The missiles can be carried by German AF Tornado, Spanish F-18 and South Korean F-15R aircraft. The missile was test launched from JAS 39 and Eurofighter aircraft. The missile is cast in one piece with only separate fins. The set contains decal sheet with stencils, 20 color photo-etched Remove Before Flight tags and plain photo-etched fret with small parts.

Germany, Spain, South Korea / Modern

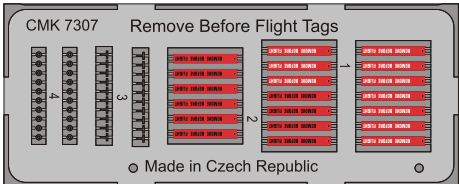

Bar Code:8595593121192

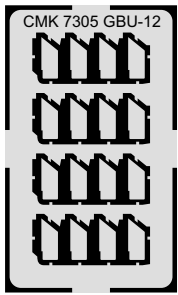

ITEM
7305

GBU-12 Paveway II Laser Guided Bomb (4 pcs)

Scale
1/72

Set contains 4 highly detailed aerial 500 Lb/ 227 Kg laser guided bombs. The bombs are cast in one piece including the fins with only separate guidance head. The set contains decal sheet with stencils, 20 color photo-etched Remove Before Flight tags and plain photo-etched fret with fins. These bombs are in use by USAF, USMC and US Navy, most European air forces, including Czech Air Force and others.

USA/ Modern

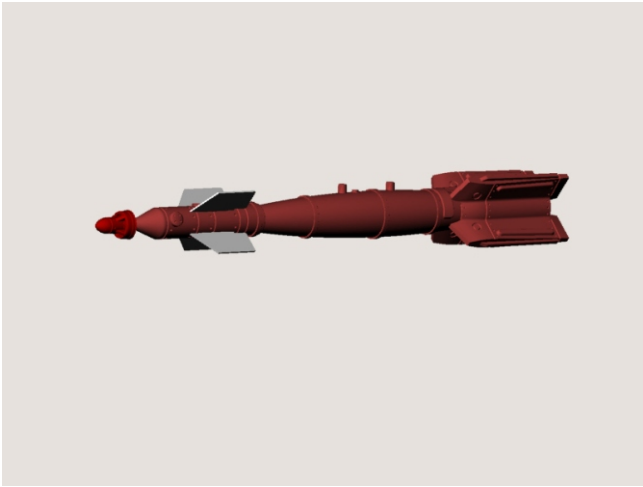

Bar Code:8595593121208

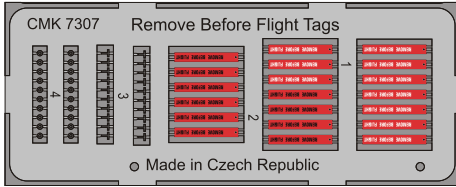

ITEM
7306

GBU-24 Paveway III Laser Guided Bomb (2 pcs)

Scale
1/72

Set contains 2 highly detailed aerial 2.000 Lb/ 910 Kg laser guided bombs. The bombs are cast in one piece including the fins with only separate guidance head. The set contains decal sheet with stencils and 20 color photo-etched Remove Before Flight tags. These bombs are used by F-15, F-16, F/A-18, Eurofighter, Mirage 2000, F-14, F-111, F-117 and others.

USA/ Modern

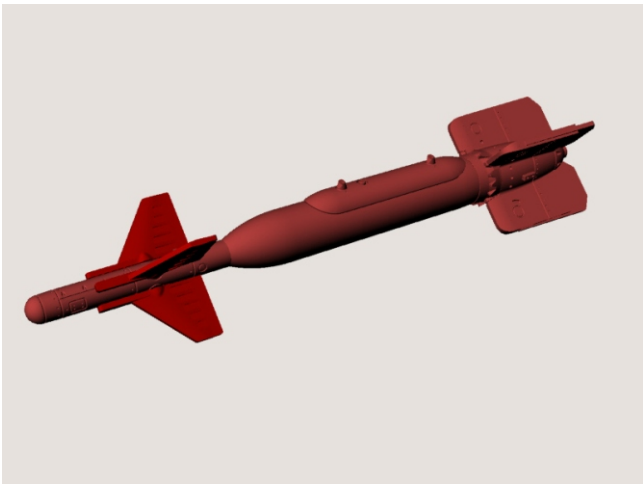

Bar Code:8595593121215

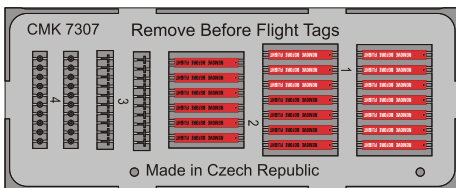

ITEM
7307

Remove Before Flight Tags (20pcs)

Scale
1/72

Set contains color photo-etched fret with 20 Remove Before Flight tags and particular attachment pins and rings used on the modern aircraft.

USA, EU / Modern

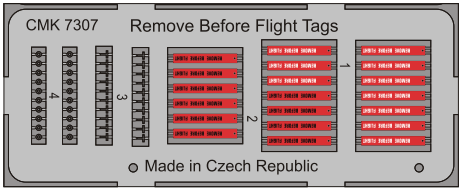

Bar Code:8595593121222

ITEM
Q72 208

Typhoon Mk.I - Exhausts
for Airfix kit

Scale
1/72

Set contains highly detailed exhaust stacks without the fairings for the WW II British fighter aircraft. Typhoon became famous as the Luftwaffe bombers' interceptor and also as the fighter bomber. The exhaust stacks were completely designed in 3D.

USA / Modern

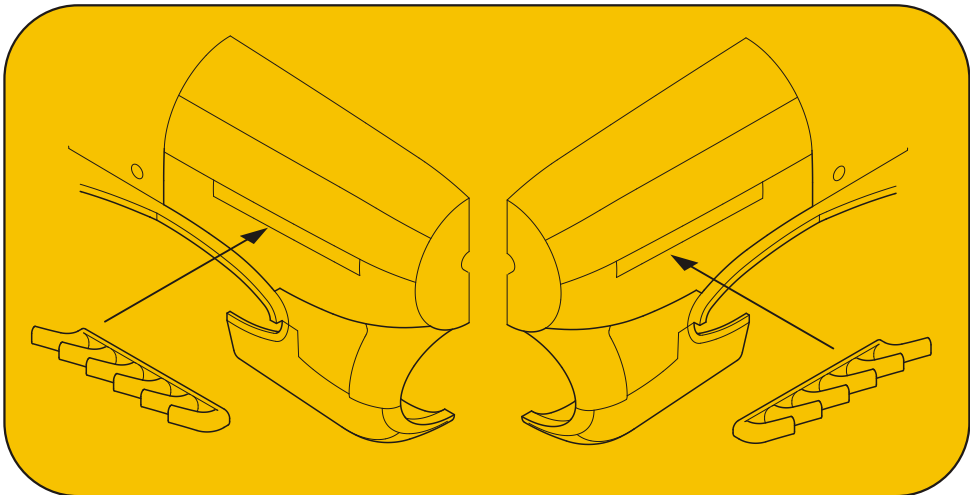

Bar Code:8595593121239



ITEM
Q72 209

Scale
1/72

AH-1G Cobra Seats for Special Hobby Kit

Highly detailed resin pilot's and gunner's seats for Special Hobby AH-1G Cobra attack helicopter. The set contains photo-etched seat harness.

USA / Modern

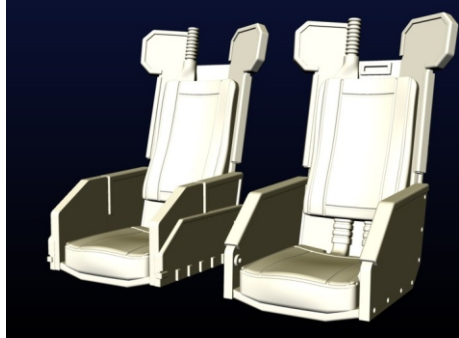

Bar Code:8595593121246

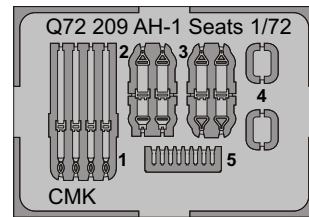
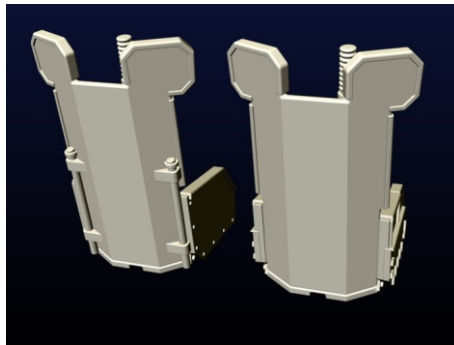
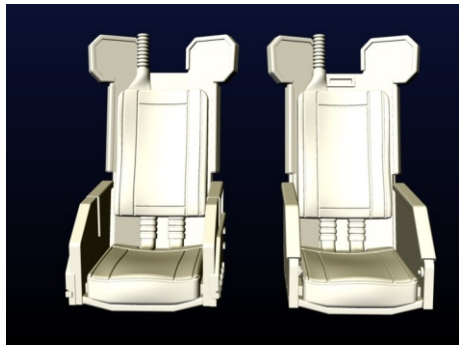

ITEM
F72 250

Scale
1/72

U-boat U-IX - Crew with Raincoats (3 fig) for Revell kit

These three WW II German submarine sailor figures were prepared to accompany the new Revell U-boat Typ IX. All three sailors are standing and wear raincoats. One of the sailors casually waves, the other hold binocular on his chest. Except of the separately cast heads and palms, all figures are cast in one piece.

Germany / WWII

Bar Code:8595593121253



Set contains highly detailed gateway of the submarine dry dock. The gates itself can be used together with other ML series sets intended for submarine diorama.
Germany / WWII

Bar Code:8595593121260

